

CYPRUS 1B
ART.NR. 280200
1/5

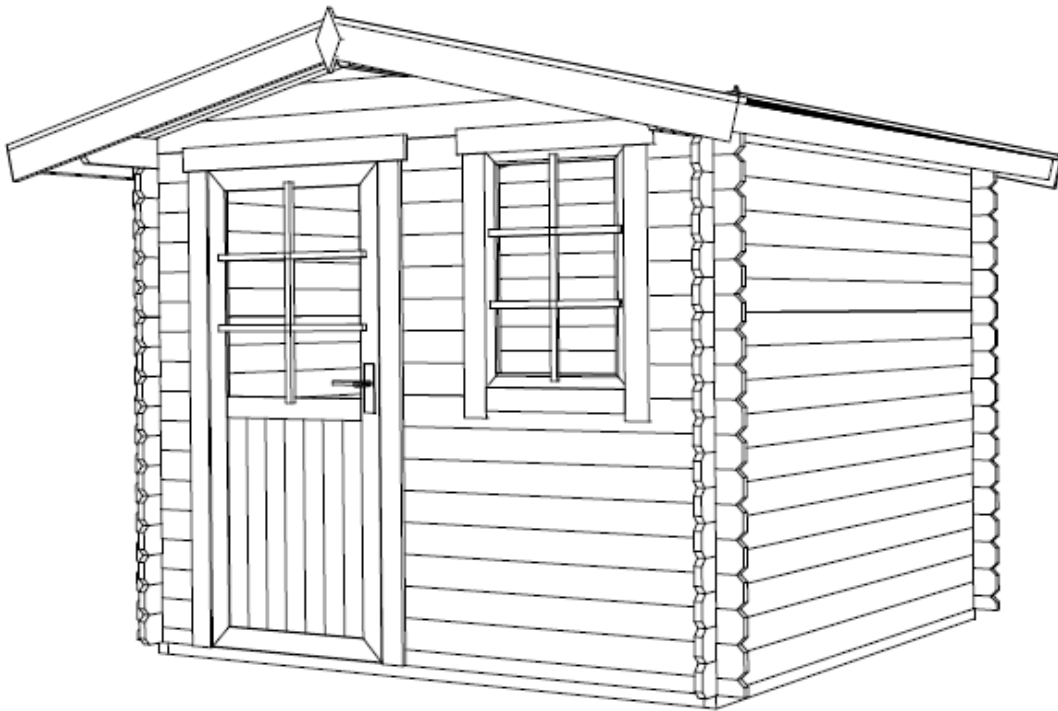

GROUNDPLAN - GRUNDPLAN - PLAN DE MASSE

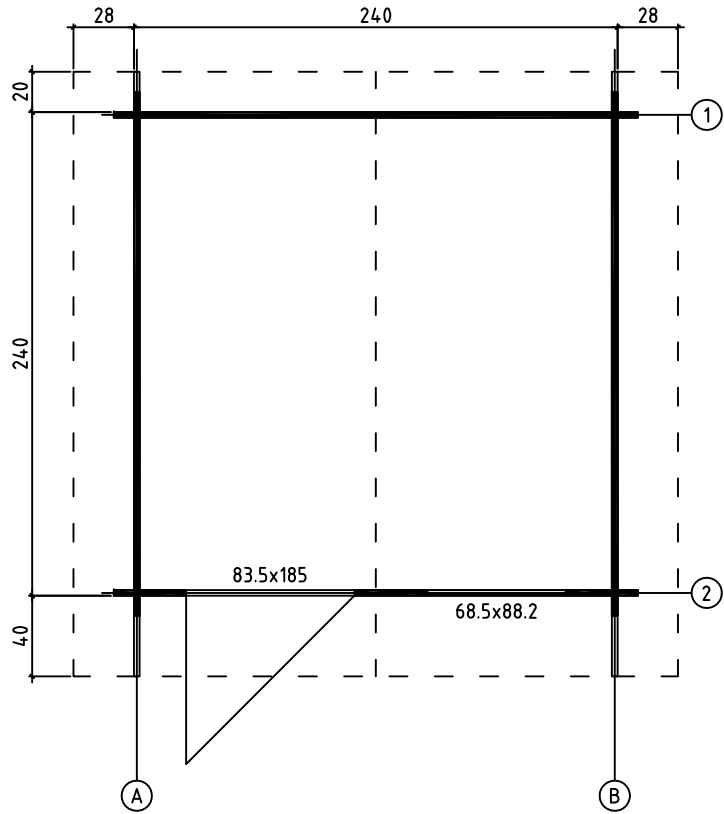



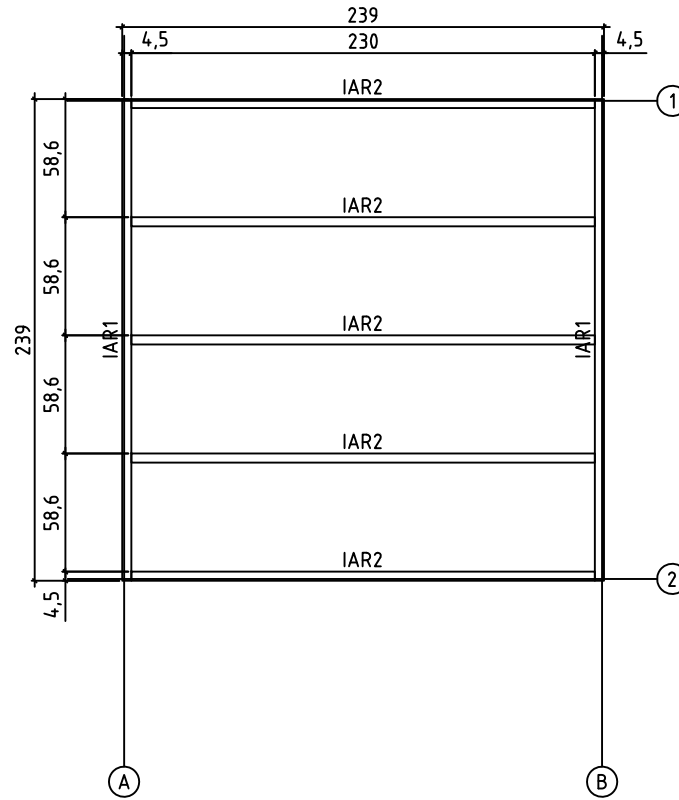



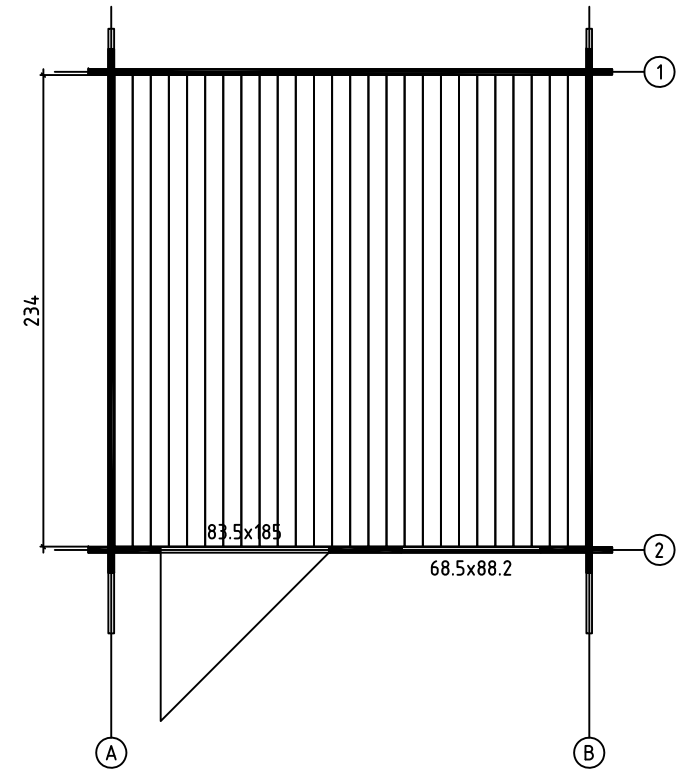





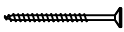

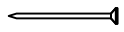
FOUNDATION - FUNDAMENT - FONDATION

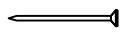

FLOOR BOARDS - FUSSBODENBRETTER - PLAN POSE PLANCHER

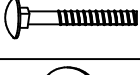

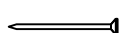
Pos	11.11.2010	ART.NR. 280200	4/5	Q.	P (mm)	L (mm)
001				1	28x57	2600
002				48	28x114	2600
006				1	28x57	354
007				1	28x57	1401
008				24	28x114	354
009				8	28x114	1401
010				8	28x114	354
011				1	28x120	3000
012				1	28x120	3000
W1-1 W2-1				1 1		
IAR1		FOUNDATION - FUNDAMENT - FONDATION		2	45x45	2390
IAR2		FOUNDATION - FUNDAMENT - FONDATION		5	45x45	2300
PR11		ROOF BEAM - DACHBALKEN - PANNE DE TOIT		1	44x120	3000
	FLOOR BOARDS - FUSSBODENBRETTER - LAME DE PLANCHER			26	90x18	2340
	ROOF BOARDS - DACHBRETTER - VOLIGES			68	90x18	1500
	FLOOR FILLET-FUSSBODENLEISTE - CORNIERE DE FINITION DU PLANCHER				18x18	9.36
	ROOFING FELT FILLET - DACHPAPPENLEISTE - BAGUETTE DE FIXATION DU FEUTRE BITUMEUX			4	18x58	1550
	EAVES BOARD - TRAUFBRETT - BANDEAU DE TOIT			2	18x90	3000
	ROOF EDGE REINFORCEMENT - DACHRANDVERSTÄRKUNG - CORNIERE DE RENFORT DE BORD DE TOIT			2	28x34	3000
	STORM PROTECTION - STURMLEISTE LATTE ANTI-TEMPETE			4	22x45	1900
	GABLE MOULDING - GIEBELLEISTE PLANCHE DE RIVE			4	18x120	1550
	WINDOW HANDLE FITTINGS-FENSTERGRIFF - POIGNÉE D'OUVERTURE DE FENETRE			1		
	SCREW FOR GABLE SEGMENT - SCHRAUBEN FÜR DECKBLATT - VIS POUR FIXATION LOSANGE DE FINITION			4	3.5x35	
	SCREW FOR DOORSTEP - SCHRAUBEN FÜR SWELLE - VIS DE FIXATION DU SEUIL DE PORTE			2	4.5x65	
	SCREW FOR GABLE MOULDING - SCHRAUBEN FÜR GIEBELLEISTE - VIS DE FIXATION POUR PLANCHE DE RIVE			16	3.5x50	

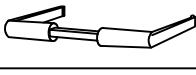
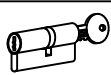
Pos	11.11.2010	ART.NR. 280200	5/5	Q.	P (mm)	L (mm)
	SCREW FOR EAVES BOARDS - SCHRAUBEN FÜR TRAUFBRETTER - VIS DE FIXATION POUR BANDEAU DE TOIT		14	4x40		
	SCREW FOR ROOF EDGE REINFORCEMENT - SCHRAUBEN FÜR DACHRANDVERSTÄRKUNG - VIS POUR RENFORT DE BORD DE TOIT		14	4x40		
	SCREW FOR ROOF BEAMS - SCHRAUBEN FÜR DACHBALKEN - VIS POUR PANNE DE TOIT		6	5x120		
	SCREW FOR 1. WALL BEAM - SCHRAUBE FÜR 1. BOHLENREIHE - VIS DE FIXATION DES FONDATIONS		6	5x90		
	SCREW FOR FUNDAMENT - SCHRAUBEN ZUR BEFESTIGUNG FUNDAMENT - VIS POUR FONDATION		10	5x90		
	ZN NAIL FOR FLOOR FILLET - ZN NÄGEL FÜR FUSSBODENLEISTE - POINTE POUR CORNIERE DE FINITION DU PLANCHER		20	1.4x40		
	HAMMER BLOCK - SCHLAGHOLZ - CALLE DE FRAPPE		1			
	ZN NAIL FOR ROOFING FELT FILLET - ZN NÄGEL FÜR DACHPAPPENLEISTE - POINTE POUR BAGUETTE FIXATION FEUTRE BITUMEUX		16	2x40		
	BOLT FOR WINDOW HANDLE FITTINGS - BOLZEN FÜR FENSTERGRIFF BESCHLAG - BOULON POUR POIGNÉE D'OUVERTURE DE FENETRE		2			
	GABLE SEGMENT-DECKBLATT - LOSANGE DE FINITION		2			
	NUT FOR STORM PROTECTION - SCHRAUBENMUTTER FÜR STURMLEISTE - ÉCROU POUR LAME ANTI-TEMPETE		8			
	BOLT FOR STORM PROTECTION - BOLZEN FÜR STURMLEISTE - VIS POUR LAME ANTI-TEMPETE		8			
	WASHER FOR STORM PROTECTION - DICHTSCHEIBE FÜR STURMLEISTE - RONDELLE POUR LAME ANTI-TEMPETE		8			
	ZN NAIL FOR ROOF - ZN NÄGEL FÜR DACHBRETTER - POINTE POUR TOIT		144	2x50		
	ZN NAIL FOR FLOOR - ZN NÄGEL FÜR FUSSBODENBRETTER - CLOUS POUR PLANCHER		135	2x50		
	SET OF DOOR LOCK COVERS - SCHLOSSBLENDEN - SET DE GARNITURES DE SERRURE DE PORTE		1			
	DOOR HANDLE FITTINGS-TÜRGRIF - SET DE GARNITURES DE SERRURE DE PORTE		1			
	CYLINDER -ZYLINDERSCHLOSS - CYLINDRE DE SERRURE		1			
	DOOR-TÜR-PORTE 835x1850	UK.2.056.SVV.MMa	1			
	WINDOW-FENSTER-FENETRE 685x882 AK.1.106.SSV.d		1			
	